



Quick Guide

GD-CI-CC4637V

EN

grundig-security.com

GRUNDIG

Quick Guide

About this guide

The guide includes instructions for using and managing the product. Pictures, charts, images and all other information hereinafter are for description and explanation only. The information contained in the guide is subject to change, without notice, due to firmware updates or other reasons.

Please find the latest version at **WWW.GRUNDIG-SECURITY.COM**

Limitation of Liability / Legal Disclaimer

Abetechs GmbH (Grundig Security) undertakes all reasonable efforts to verify the integrity and correctness of the contents in this document, but no formal guarantee shall be provided. Use of this document and the subsequent results shall be entirely on the user's own responsibility. Abetechs GmbH (Grundig Security) reserves the right to change the contents of this document without prior notice. Design and specifications are subject to change without prior notice.

The product described herein, with its hardware, software and documentation is provided "as is", without any warranty, expressed or implied, including without limitation, merchantability, satisfactory quality, fitness for a particular purpose, and non-infringement of a third party.

In no event will our company and its employees or agents be liable to you for any special, consequential, incidental, or indirect damages, including among others, damages for loss of business profits, business interruption, or loss of data or documentation, in connection with the

use of this product, even if our company has been advised of the possibility of such damages.

Regarding to products with internet access, the use of the product shall be wholly at your own risks. Our company shall not take any responsibilities for abnormal operation, privacy leakage or other damages resulting from cyber-attack, hacker attack, virus inspection, or other internet security risks; however our company will provide timely technical support if required. Surveillance laws vary by jurisdiction before using this product in order to ensure that your use conforms to the applicable law. Our company shall not be liable in the event that this product is used with illegitimate purposes.

In the event of any conflicts between this manual and the applicable law, the later prevails.

Trademark:

Each of trademarks herein is registered. The name of this product and other trademarks mentioned in this manual are the registered trademark of their respective company.

Copyright of this document is reserved. This document shall not be reproduced, distributed or changed, partially or wholly, without formal authorization.

OPEN SOURCE SOFTWARE LICENSE INFORMATION

The software components provided with Grundig products may contain copyrighted software that is licensed under various open source software licenses. For detailed information about the contained open source software packages, the used package versions,

license information and complete license terms, please refer to the product detail pages on our website. The complete open source software license information is also included in firmware files of affected products. Please also check your manuals for additional information.

You may obtain the complete corresponding open source part of a specific product from us for a period of three years after our last shipment of this product by sending an email to: info@grundig-security.com

Safety and Installation Instructions

Introduction

Please read these instructions carefully and keep them for future reference. You must heed all the warnings and cautions as well as follow all the safety and installation instructions.

The appearance of the products, functions and firmware or software upgrade may differ from this manual.

GRUNDIG reserves the right to perform needed changes without prior notice.

Safety Instructions

Make sure that you only use the power adapter that is specified in the specifications sheet of the product. If you use any other adapter or connect the power supply incorrectly, this may cause explosion, fire, electric shocks or damage the product. Do not connect several devices

to one power adapter as this may cause an adapter overload and can lead to over-heating and fire. Make sure that the plug of the power adapter is firmly connected to the power socket.

Do not place containers with liquids on the product. Do not place conducting items like tools, screws, coins or other metal items on the product. These may fall from the product or can cause fire or electric shocks or other physical injuries.

Do not push or insert any sharp items or any objects into the device as this may cause damage to the product, fire, electric shocks and/or physical injuries.

Do not block any ventilation openings, if there are any. Ensure that the product is well ventilated to prevent any over-heating.

Do not subject the device to physical shock or drop the product.

If the product uses batteries, please use a battery type that is recommended by the manufacturer. Improper use or replacement of the battery may result in the hazard of explosion.

Do not use any accessories that are not recommended by GRUNDIG. Do not modify the product in any way.

If the product starts to smell or smoke comes out of the device, immediately stop using the product and disconnect it from the power supply to prevent fire or electric shocks. Then contact your dealer or the nearest service center.

If the product does not work correctly, contact your dealer or nearest service center. Never open, disassemble or alter the product yourself. GRUNDIG cannot accept any liability or responsibility for problems caused by attempted and unauthorized repair and maintenance.

Installation Instructions

It is necessary to fix the device firmly if the product is installed on a wall or ceiling. Do not install the product on surfaces or in places that are vibrating. Do not install the product near radiation sources.

Do not install the product near heat sources, like radiators or other equipment that produces some heat. If the product is not classified by any IP class, do not install the product in very cold or hot temperatures (please refer to the working temperature specified in the specification sheet of the product), dusty, dirty or damp environment.

If the product is classified by any IP class, never touch the product cover directly with your fingers, because the acidic sweat of the fingers may damage the surface coating of the product cover. To clean the inside and outside of the product cover, use a soft and dry cloth. In any case, do not use alkaline detergents. The correct configuration of all passwords and other security settings is the sole responsibility of the installer and/or end-user (this applies especially to IP Cameras and Recorders).

Special Installation Instructions for Cameras

Do not touch the sensor module with your fingers. Do not aim the camera or camera lens at a strong light such as the sun or a bright lamp. Irreversible damage to the camera can be caused by a strong light.

Do not expose the sensor of the product to laser beams as this may damage the sensor.

If the product supports IR, you need to take some precautions to prevent IR reflection. Do not install the product close to reflective surfaces of objects as this may cause reflection. If the product has a

dome cover, please remove the protection film only after installation to prevent dust or grease on the camera which can cause reflection. The foam ring around the lens must be seated flush against the inner surface of the bubble to isolate the lens from the IR LEDs. Fasten the dome cover to the camera body so that the foam ring and the dome cover are attached seamlessly.

For cleaning, use a clean cloth with a bit of ethanol and wipe it carefully and gently. In any case, do not use alkaline detergents.

If a glove is provided in the package, please use it to open the product cover. Never touch the product cover directly with fingers, because the acidic sweat of the fingers may damage the surface coating of the product cover.

Special Installation Instructions for IP Cameras

Make sure that the latest firmware is installed on the IP Device. You may get the latest firmware from techsupport@grundig-security.com.

Table of Contents

1 Appearance Description	8
1.1 Camera overview	8
2 Installation	10
2.1 Memory Card Installation.....	10
2.2 Installation	11
3 Setting the IP-Camera over the LAN	16
3.1 Wiring	16
3.2 Activating the Camera	17
3.2.1 Activation via Web Browser	17
3.2.2 Activation via IP-Finder Software	18
3.3 Modifying the IP Address	20
4 Accessing via Web Browser	22
4.1 Initializing the Memory Card	24

1 Appearance Description

1.1 Camera overview

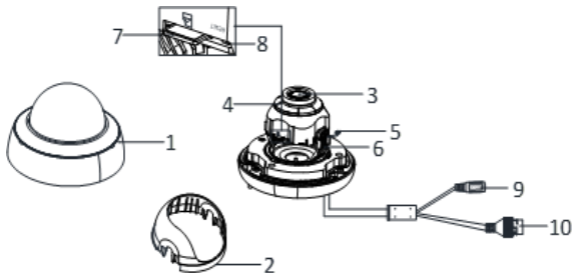

Figure 1-1 Camera Overview

Table 1-1 Description Camera

No.	Description
1	Bubble
2	Black liner
3	Lens
4	IR LED

5	Safety rope
6	Lens rotation bracket
7	Memory card slot
8	Reset button
9	Power Interface
10	Network Interface

Note: Power on the camera when pressing the RESET button, and press button for another 10 seconds to restore the default settings, including the user name, password, IP address, port No., etc.

2 Installation

2.1 Memory Card Installation

The camera supports a memory card as local storage. Follow these steps to insert and remove the memory card.

Steps:

1. Loosen the screws on the dome. Remove the dome cover to expose the memory card slot.

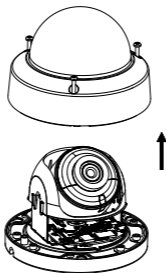

Figure 2-1 Remove Dome Cover

Note:

- The screws of the dome can not be completely unscrewed to avoid loss.
- The dome is attached to the camera with a safety cable.

-
2. Locate the memory card slot to insert the memory card.

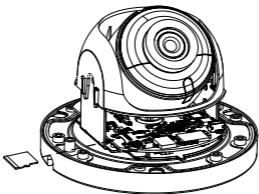

Figure 2-2 Insert Memory Card

3. (Optional) Press on the memory card to remove it.

2.2 Installation

Steps:

1. Attach the dill template to the ceiling.
2. Drill the screw holes and cable hole (optional) in the ceiling according to the drill template.

Note: Cable hole is required when you adopt ceiling outlet to route the cables.

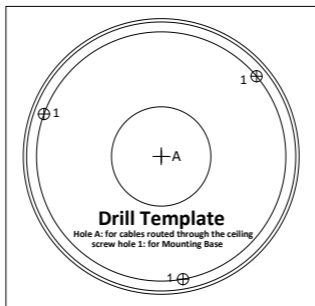

Figure 2-3 Drill Template

3. Loosen the set screws with a hex wrench (supplied) to remove the bubble.

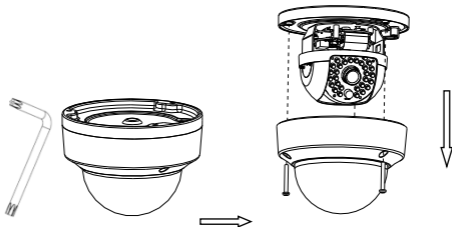
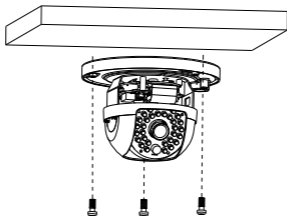

Figure 2-4 Remove the Bubble

-
4. Fix the mounting base on the ceiling with supplied screws.

Figure 2-5 Fix the Mounting Base

5. Route the cables through the cable hole.



Note: If required, you can route cables through the side opening on the side of the mounting base.

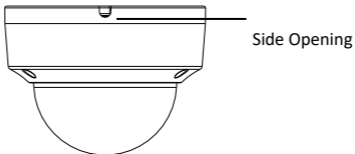

Figure 2-6 Side Opening

6. Connect the corresponding cables, such as power cable and network cable.

-
7. Power on the camera to check whether the image on the monitor is gotten from the optimum angle. If not, adjust the camera to get an optimum angle.

Notes:

- The camera supports 3-axis adjustment. Loosen the tilt adjusting screw to adjust the tilt angle [0° to 75°], hold the black liner to adjust the pan angle [0° to 355°], and hold the lens to rotate the camera [0° to 355°]. See the figure below.

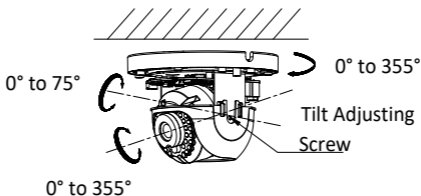

Figure 2-7 Camera 3-Axis Adjustment

Adjust zoom and focus.

For the camera with MFZ lens you can adjust the zoom and focus levels on the PTZ control panel by accessing the camera through a web browser or client software.

For detailed instructions please refer to the instruction manual.

PTZ



Figure 2-8 Zoom and Focus Adjusting with Browser

8. Reinstall the bubble, and tighten the screws.

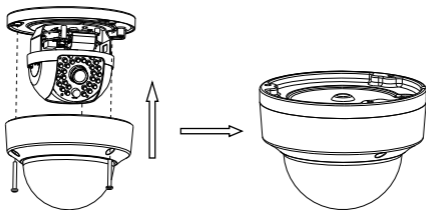

Figure 2-9 Bubble Reinstallation

3 Setting the IP-Camera over the LAN

Note:

You shall acknowledge that the use of the product with Internet access might be under network security risks. For avoidance of any network attacks and information leakage, please strengthen your own protection.

If the product does not work properly, contact your dealer or the nearest service center for help.

3.1 Wiring

Connect the camera to network according to the following figures.

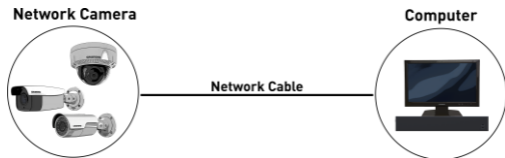

Figure 3-1 Connecting Directly

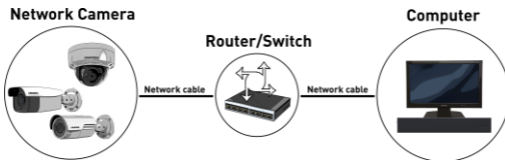

Figure 3-2 Connecting via a Switch or a Router

3.2 Activating the Camera

You are required to activate the camera first by setting a strong password for it before you can use the camera.

Activation via Web Browser, Activation via Grundig IP-Finder, and Activation via Client Software are all supported. We will take activation via Grundig IP-Finder software and Activation via Web Browser as examples to introduce the camera activation.

3.2.1 Activation via Web Browser

Steps:

1. Power on the camera. Connect the camera to your computer or the switch/router which your computer connects to.
2. Input the IP address into the address bar of the web browser, and press Enter to enter the activation interface.

Notes:

- The default IP address of the camera is 192.168.1.100.
- The computer and the camera should belong to the same subnet.
- For the camera enables the DHCP by default, you need to use the Grundig IP-Finder software to search the IP address.

Activation

User Name admin

Password

Valid password range [8-16]. You can use a combination of numbers, lowercase, uppercase and special character for your password with at least two kinds of them contained.

Confirm

OK

Figure 3-3 Activation Interface (Web)

3. Create a password and input the password into the password field.



STRONG PASSWORD RECOMMENDED— *We highly recommend you create a strong password of your own choosing (using a minimum of 8 characters, including upper case letters, lower case letters, numbers, and special characters) in order to increase the security of your product. And we recommend you reset your password regularly, especially in the high security system, resetting the password monthly or weekly can better protect your product.*

4. Confirm the password.
5. Click **OK** to save the password and enter the live view interface.

3.2.2 Activation via IP-Finder Software

Grundig Finder software is used for detecting the online device and activating the camera.

Get the Grundig Finder software from the official website www.grundig-security.com and install the software according to the prompts. Follow the steps to activate the camera, please refer to the User manual for other two activation methods.

Steps:

1. Run the Finder software to search the online devices.
2. Check the device status from the device list and select the inactive device.

The screenshot shows the Grundig IP-Finder software interface. The main window displays a table of discovered devices. The table has columns for ID, Brand, Model, Location, Status, Type, IP, Host, Gateway, UP Time, CPU Use, Serial Number, and MAC. The status of each device is shown as either 'Inactive' or 'Active'. On the right side, there is a panel titled 'Activate the device' which contains a red padlock icon and the text 'The device is not activated!'. Below this, there is a 'Security activation' section with fields for 'User:', 'Password:', and 'Confirm password:', followed by an 'Activate' button.

ID	Brand	Model	Location	Status	Type	IP	Host	Gateway	UP Time	CPU Use	Serial Number	MAC
1	Grundig	GG-C476021V		Inactive	IP	192.168.0.40			00	00		
2	Grundig	GG-C476021V		Inactive	IP	192.168.0.36			00	00		
3	Grundig	GG-C476021V		Inactive	IP	192.168.0.2			00	00		
4	Grundig	GG-C369031V		Inactive	IP	192.168.0.0			00	00		
5	Grundig	GG-C472031V		Inactive	IP	192.168.2.108			00	00		
6	Grundig	GG-C476021V		Inactive	IP	192.168.2.5			00	00		
7	Grundig	GG-4747004P		Inactive	IP	192.168.2.204			00	00		
8	Grundig	GGV-4C3603V	V26.34.8.2.3_236...	Active	IP	192.168.2.14	255.255.255.0	192.206.2.0	00	0	AA:0A:22:AB:00:06	
9	Grundig	GGV-4C3603V	V26.34.8.2.3_236...	Active	On	192.168.0.19	255.255.255.0	192.206.8.45	00	0	AA:0A:22:AB:00:10	
10	Grundig	GGV-4C3603V	V31.35.8.2.3_236...	Active	On	192.168.0.64	255.255.255.0	192.206.8.45	00	0	AA:0A:22:AB:00:14	
11	Grundig	GGV-4C3603V	V31.35.8.2.3_236...	Active	On	192.168.0.102	255.255.255.0	192.206.8.45	00	0	AA:0A:22:AB:00:41	
12	Grundig	GGV-4C3603V	V31.35.8.2.3_236...	Active	IP	18.93.25.102	255.255.255.0	10.103.1	00	0	AA:0A:22:AB:00:25	
13	Grundig	GGV-4C3603V	V31.35.8.2.3_236...	Active	On	192.168.0.43	255.255.255.0	192.206.8.45	00	0	AA:0A:22:AB:00:4E	
14	Grundig	GGV-4C3603V	V31.35.8.2.3_236...	Active	On	192.168.0.43	255.255.255.0	192.206.8.45	00	0	AA:0A:22:AB:00:4D	
15	Grundig	GGV-4C3603V	V31.35.8.2.3_236...	Active	On	192.168.2.16	255.255.255.0	192.206.2.0	00	0	AA:0A:22:AB:00:3A	
16	Grundig	GGV-4F3203N	V8.2.5.2.022043	Active	IP	192.168.2.159	255.255.255.0	00.0.0	00	0	AA:0A:22:AB:00:74	
17	Grundig	GGV-4C3603V	V8.2.5.2.0220721	Active	On	192.168.0.33	255.255.255.0	192.206.8.45	00	0	AA:0A:22:AB:00:06	
18	Grundig	GGV-4C3603V	V8.2.5.2.0220721	Active	On	192.168.0.34	255.255.255.0	192.206.8.45	00	0	AA:0A:22:AB:00:08	

Figure 3-4 Grundig IP-Finder Interface

Note:

The software supports activating the camera in batch. Refer to the user manual of Grundig Finder software for details.

3. Create and input the new password in the password field, and confirm the password.



STRONG PASSWORD RECOMMENDED– *We highly recommend you create a strong password of your own choosing (using a minimum of 8 characters, including upper case letters, lower case letters, numbers, and special characters) in order to increase the security of your product. And we recommend you reset your password regularly, especially in the high security system, resetting the password monthly or weekly can better protect your product.*

4. Click **Activate** to start activation.

You can check whether the activation is completed on the popup window. If activation failed, make sure that the password meets the requirement and try again.

3.3 Modifying the IP Address

Purpose:

To view and configure the camera via LAN (Local Area Network), you need to connect the network camera in the same subnet with your PC.

Use the Grundig IP-Finder software or client software to search and change the IP address of the device. We take modifying the IP Address via Grundig IP-Finder software as an example to introduce the IP address modification.

For IP address modification via client software, refer to the user manual of client software.

Steps:

1. Run the Grundig IP-Finder software.
2. Select an activate device.
3. Change the device IP address to the same subnet with your computer by either modifying the IP address manually or checking the checkbox of Enable DHCP.

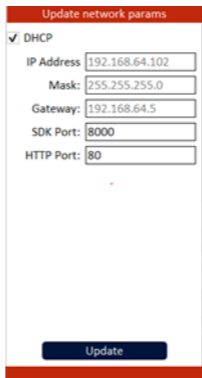

Update network params

DHCP

IP Address: 192.168.64.102

Mask: 255.255.255.0

Gateway: 192.168.64.5

SDK Port: 8000

HTTP Port: 80

Update

Figure 3-5 Modify the IP Address

4. Input the admin password and click **Update** to activate your IP address modification.

The batch IP address modification is supported by the Grundig IP-Finder. Please refer to the User Manual of Grundig IP-Finder for details.

4 Accessing via Web Browser

System Requirement:

Operating System: Microsoft Windows XP SP1 and above version

CPU: 2.0 GHz or higher

RAM: 1G or higher

Display: 1024×768 resolution or higher

Web Browser: Internet Explorer 8 and above version, Apple Safari 16 and above version, Mozilla Firefox 52.0 and above version and Google Chrome 57.0 and above version.

Steps:

1. Open the web browser.
2. In the browser address bar, input the IP address of the network camera, and press the **Enter** key to enter the login interface.

Note:

- The default IP address is 192.168.1.100. You are recommended to change the IP address to the same subnet with your computer.

3. Input the user name and password.

The admin user should configure the device accounts and user/operator permissions properly. Delete the unnecessary accounts and user/operator permissions.

Note:

The device IP address gets locked if the admin user performs 7 failed password attempts (5 attempts for the user/operator).

4. Click **Login**.



Figure 4-1 Login Interface

5. Install the plug-in before viewing the live video and managing the camera. Please follow the installation prompts to install the plug-in.

Note:

You may have to close the web browser to finish the installation of the plug-in.

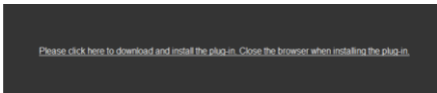

Figure 4-2 Download Plug-in

6. Reopen the web browser after the installation of the plug-in and repeat steps 2 to 4 to login.

Note:

For detailed instructions of further configuration, please refer to the user manual.

4.1 Initializing the Memory Card

Steps:

Check the memory card status by tapping on the Storage Status in the Device Settings interface.

If the memory card status displays as uninitialized, tap to initialize it. The status will then change to Normal. You can then start recording any event triggered video in the camera such as motion detection.

QG-GD-CI-CC4637V-2023-08-14-V5-EN ©ABETECHS GMBH, DÜSSELDORF, GERMANY

grundig-security.com

GRUNDIG